

NOTE:

- Acosorb products always need to be applied accordingly to the instructions by Acosorb on clean, dry and non expanding surfaces like concrete, gypsum or eq
Dimensions of profiles and other products depends on the applied thickness of Acosorb product.

Product:	ACOPLASTER F STANDARD ENDING	Date:	V1.0 2019	info@acosorb.com
Scale:	1:2	Drawn by:	ACOSORB	WWW.ACOSORB.COM
Papersize:	A4			 seamless acoustical spray- and plasterwork

* These details are basic principle drawings. This drawing does not function as or will replace any execution drawings.
The client or contractor is responsible for the correct application of the product. All dimensions need to be checked by client or contractor.

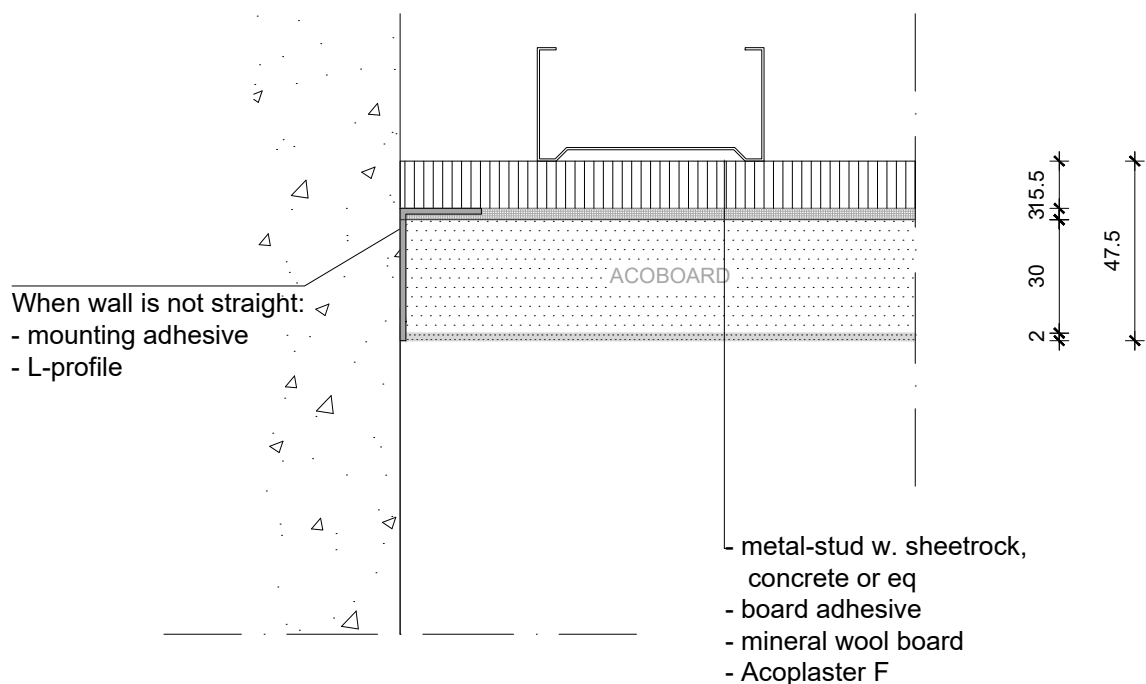

NOTE:

- Acosorb products always need to be applied accordingly to the instructions by Acosorb on clean, dry and non expanding surfaces like concrete, gypsum or eq
 Dimensions of profiles and other products depends on the applied thickness of Acosorb product.

Product:	ACOPLASTER F WALL CONNECTION	Date:	V1.0 2019	info@acosorb.com
Scale:	1:2	Drawn by:	ACOSORB	WWW.ACOSORB.COM
Papersize:	A4			 seamless acoustical spray- and plasterwork

* These details are basic principle drawings. This drawing does not function as or will replace any execution drawings.
 The client or contractor is responsible for the correct application of the product. All dimensions need to be checked by client or contractor.

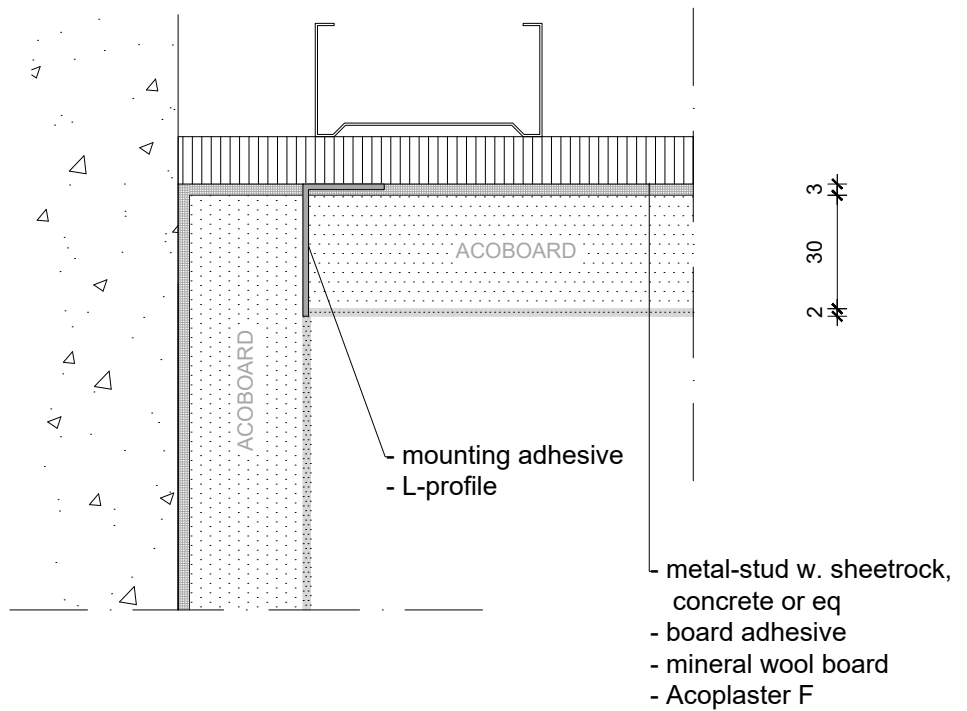

NOTE:

- Acosorb products always need to be applied accordingly to the instructions by Acosorb on clean, dry and non expanding surfaces like concrete, gypsum or eq
Dimensions of profiles and other products depends on the applied thickness of Acosorb product.

Product:	ACOPLASTER F INTERNAL CORNER	Date:	V1.0 2019	info@acosorb.com
Scale:	1:2	Drawn by:	ACOSORB	WWW.ACOSORB.COM
Papersize:	A4			 seamless acoustical spray- and plasterwork

* These details are basic principle drawings. This drawing does not function as or will replace any execution drawings.
The client or contractor is responsible for the correct application of the product. All dimensions need to be checked by client or contractor.

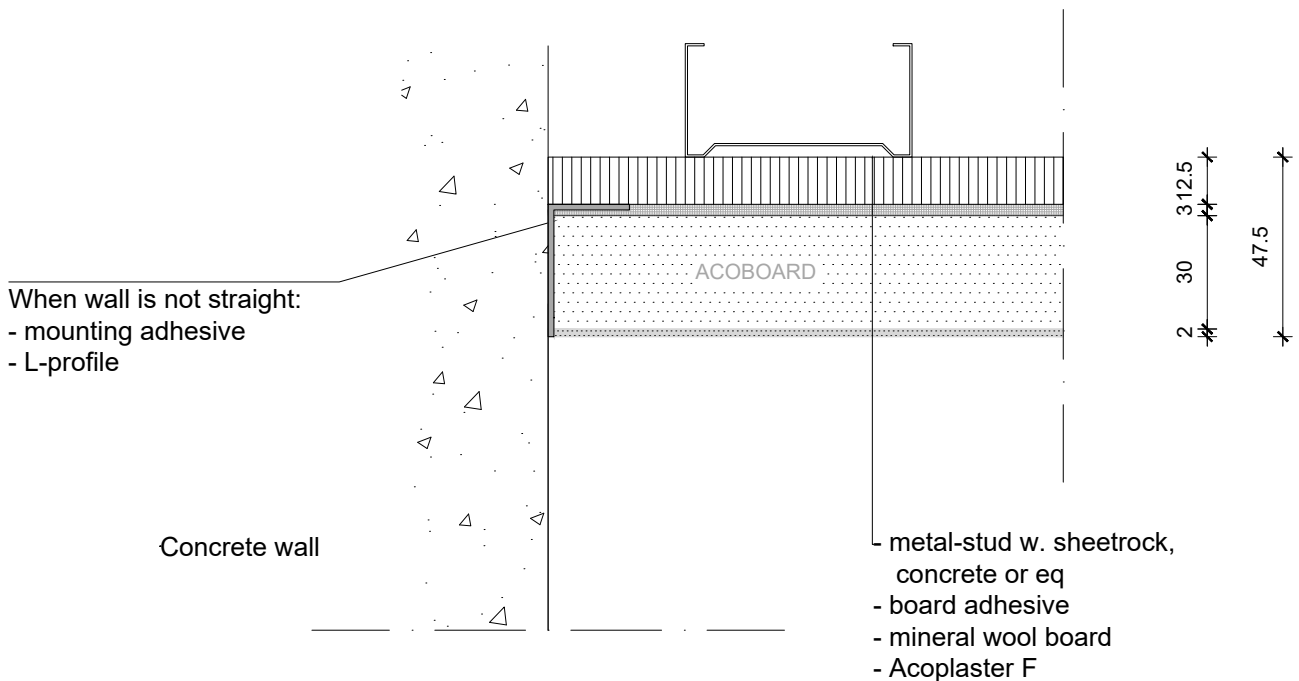
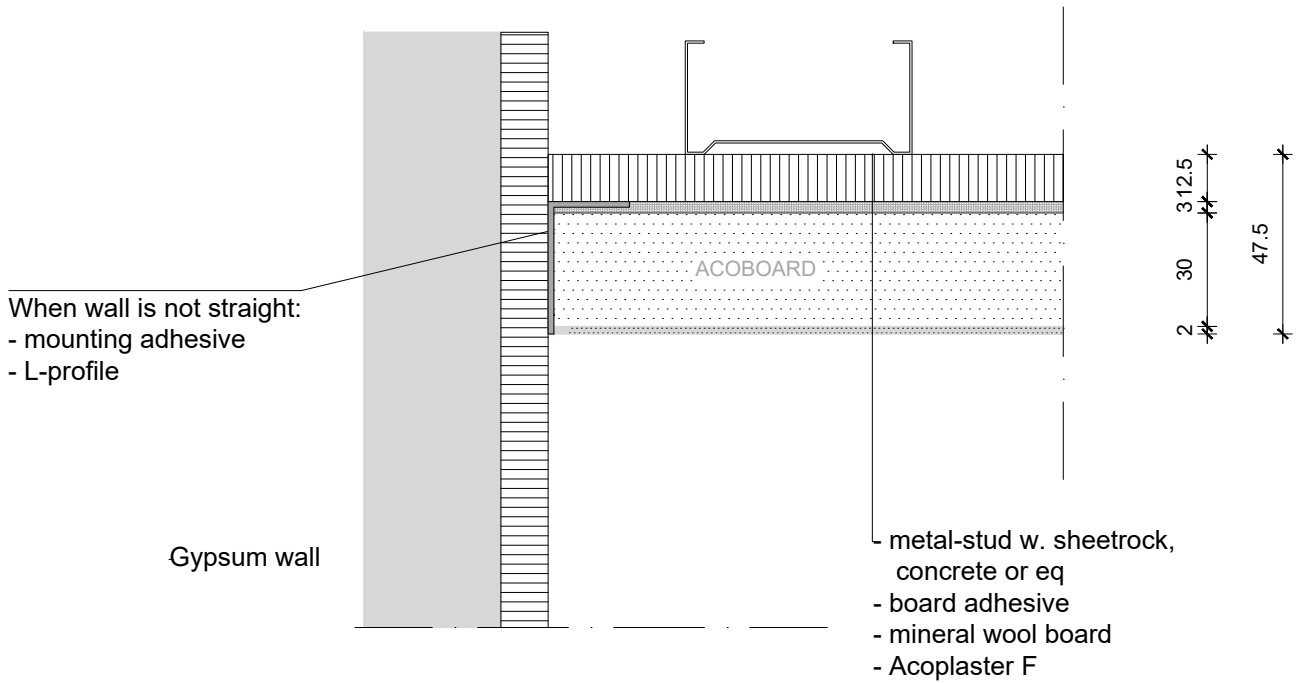

NOTE:

- Acosorb products always need to be applied accordingly to the instructions by Acosorb on clean, dry and non expanding surfaces like concrete, gypsum or eq
 Dimensions of profiles and other products depends on the applied thickness of Acosorb product.

Product:	ACOPLASTER F WALL CONNECTION	Date:	V1.0 2019	info@acosorb.com
Scale:	1:2	Drawn by:	ACOSORB	WWW.ACOSORB.COM
Papersize:	A4	 seamless acoustical spray- and plasterwork		

* These details are basic principle drawings. This drawing does not function as or will replace any execution drawings.
 The client or contractor is responsible for the correct application of the product. All dimensions need to be checked by client or contractor.

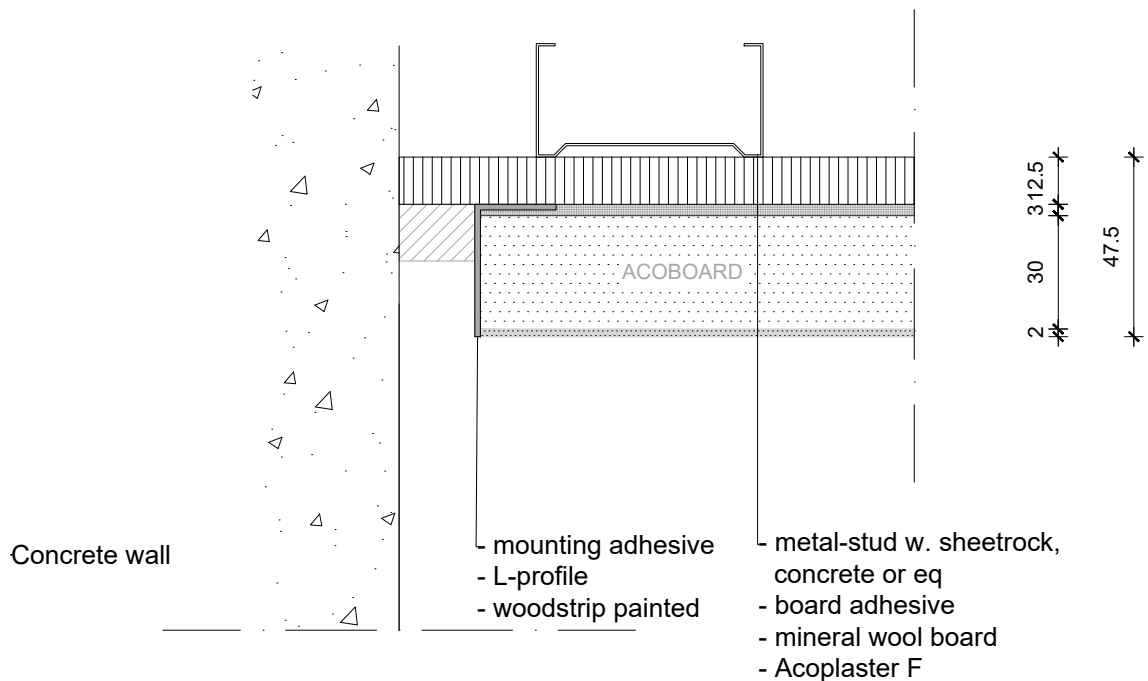
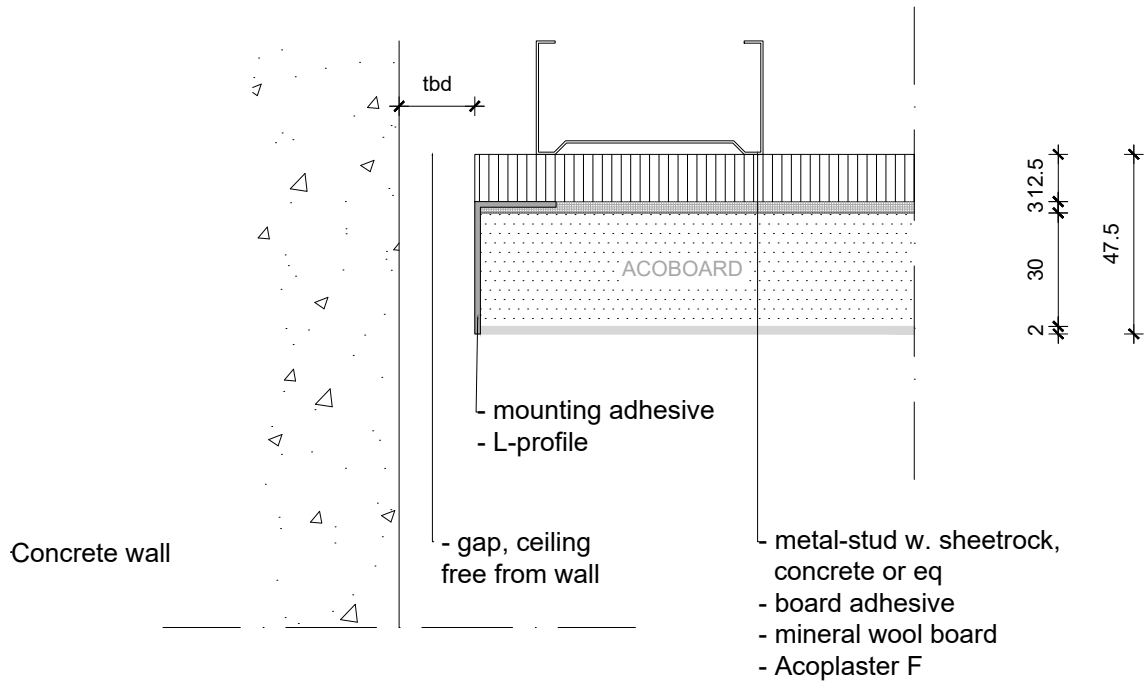

NOTE:

- Acosorb products always need to be applied accordingly to the instructions by Acosorb on clean, dry and non expanding surfaces like concrete, gypsum or eq
Dimensions of profiles and other products depends on the applied thickness of Acosorb product.

Product:	ACOPLASTER F WALL/SHADOW JOINT	Date:	V1.0 2019	info@acosorb.com
Scale:	1:2	Drawn by:	ACOSORB	WWW.ACOSORB.COM
Papersize:	A4	 seamless acoustical spray- and plasterwork		

* These details are basic principle drawings. This drawing does not function as or will replace any execution drawings.
The client or contractor is responsible for the correct application of the product. All dimensions need to be checked by client or contractor.

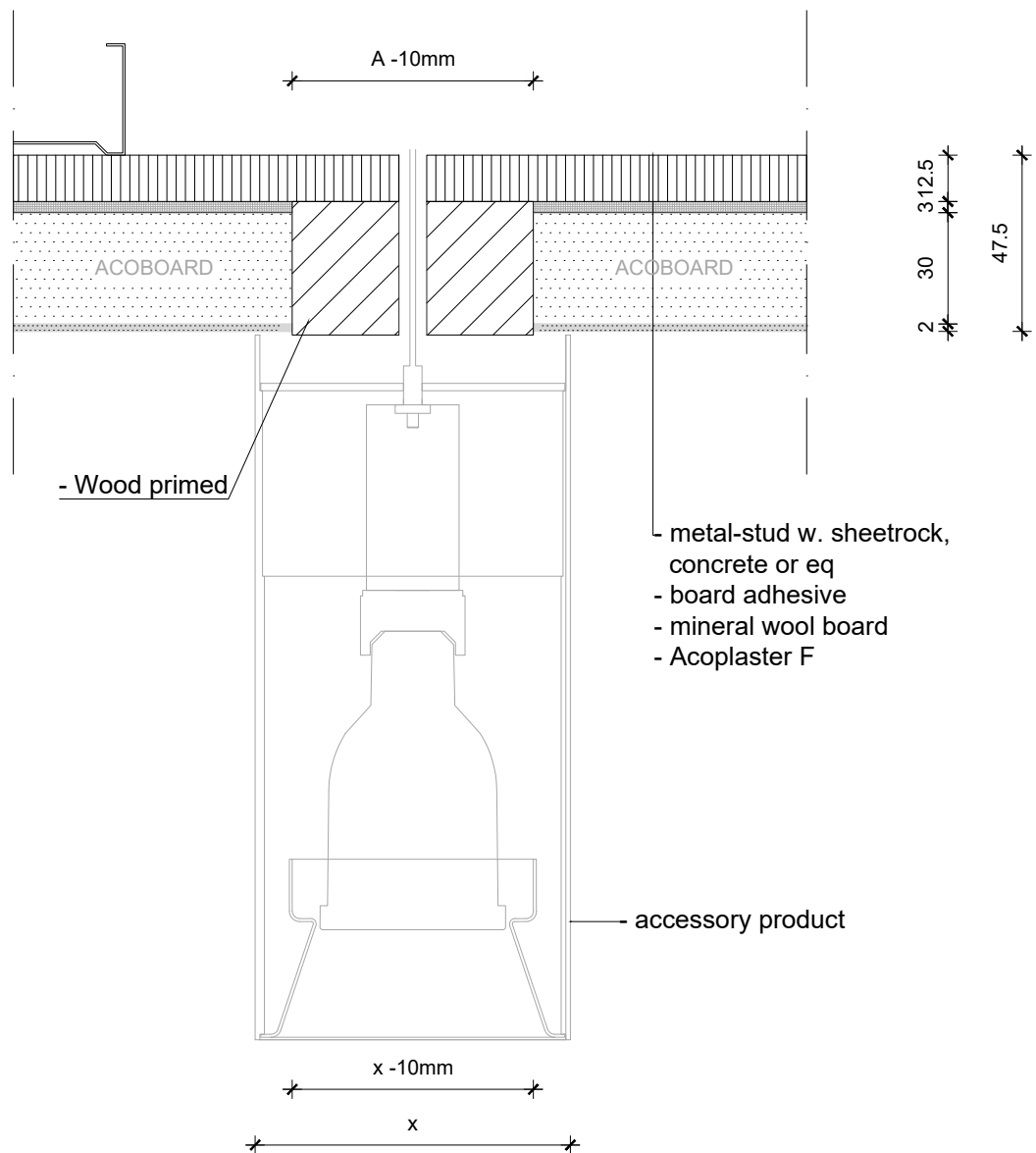

NOTE:

- Acosorb products always need to be applied accordingly to the instructions by Acosorb on clean, dry and non expanding surfaces like concrete, gypsum or eq
 Dimensions of profiles and other products depends on the applied thickness of Acosorb product.

Product:	ACOPLASTER F CEILING SURFACE MOUNTED	Date:	V1.0 2019	info@acosorb.com
Scale:	1:2	Drawn by:	ACOSORB	WWW.ACOSORB.COM
Papersize:	A4	 seamless acoustical spray- and plasterwork		

* These details are basic principle drawings. This drawing does not function as or will replace any execution drawings.
 The client or contractor is responsible for the correct application of the product. All dimensions need to be checked by client or contractor.

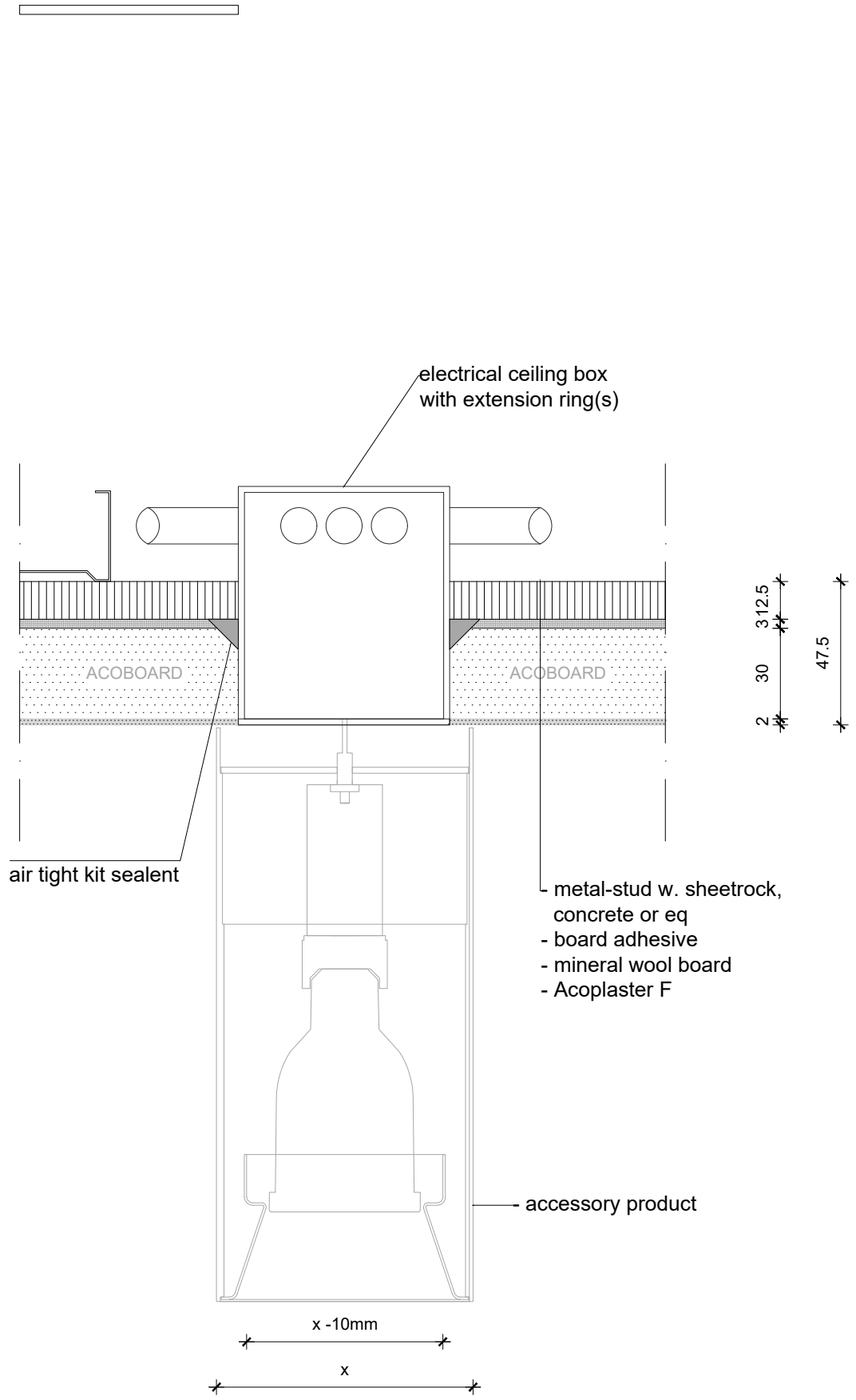

NOTE:

- Acosorb products always need to be applied accordingly to the instructions by Acosorb on clean, dry and non expanding surfaces like concrete, gypsum or eq
 Dimensions of profiles and other products depends on the applied thickness of Acosorb product.

Product:	ACOPLASTER F ELECTRICAL CEILING BOX	Date:	V1.0 2019	info@acosorb.com
Scale:	1:2	Drawn by:	ACOSORB	WWW.ACOSORB.COM
Papersize:	A4			 seamless acoustical spray- and plasterwork

* These details are basic principle drawings. This drawing does not function as or will replace any execution drawings. The client or contractor is responsible for the correct application of the product. All dimensions need to be checked by client or contractor.

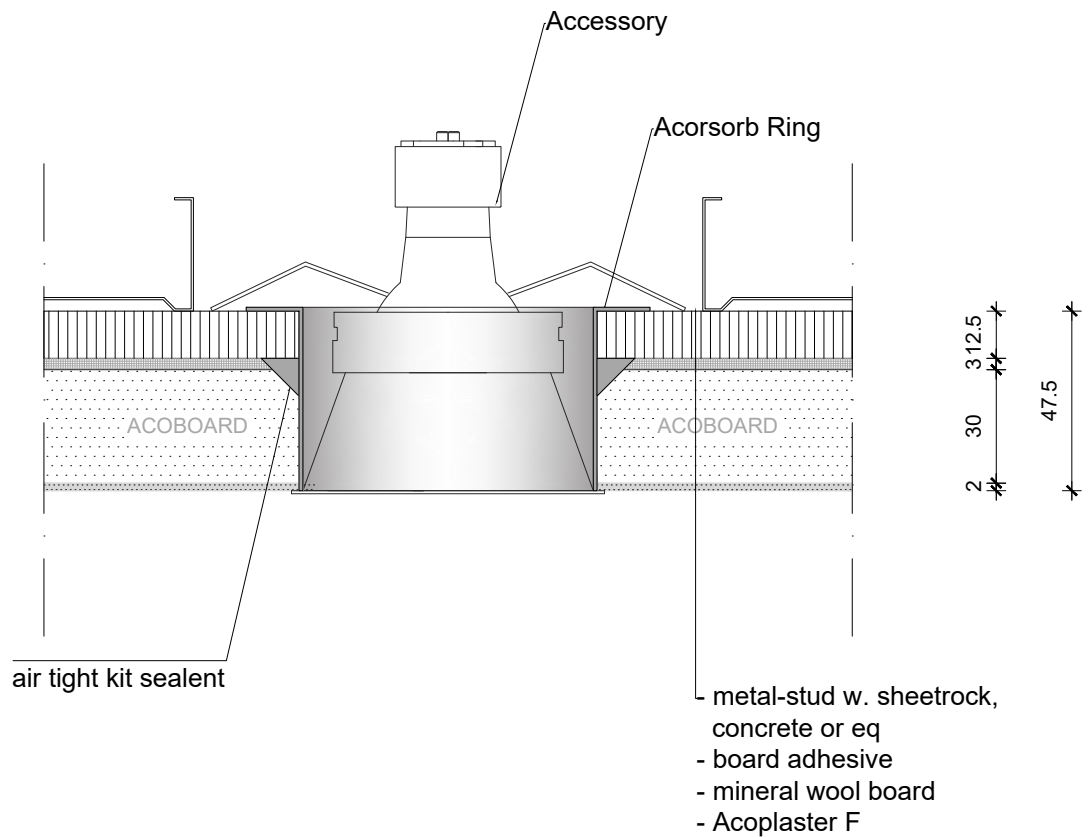

NOTE:

- Acosorb products always need to be applied accordingly to the instructions by Acosorb on clean, dry and non expanding surfaces like concrete, gypsum or eq
Dimensions of profiles and other products depends on the applied thickness of Acosorb product.

Product:	ACOPLASTER F ACOSORB RING	Date:	V1.0 2019	info@acosorb.com
Scale:	1:2	Drawn by:	ACOSORB	WWW.ACOSORB.COM
Papersize:	A4			 seamless acoustical spray- and plasterwork

* These details are basic principle drawings. This drawing does not function as or will replace any execution drawings.
The client or contractor is responsible for the correct application of the product. All dimensions need to be checked by client or contractor.

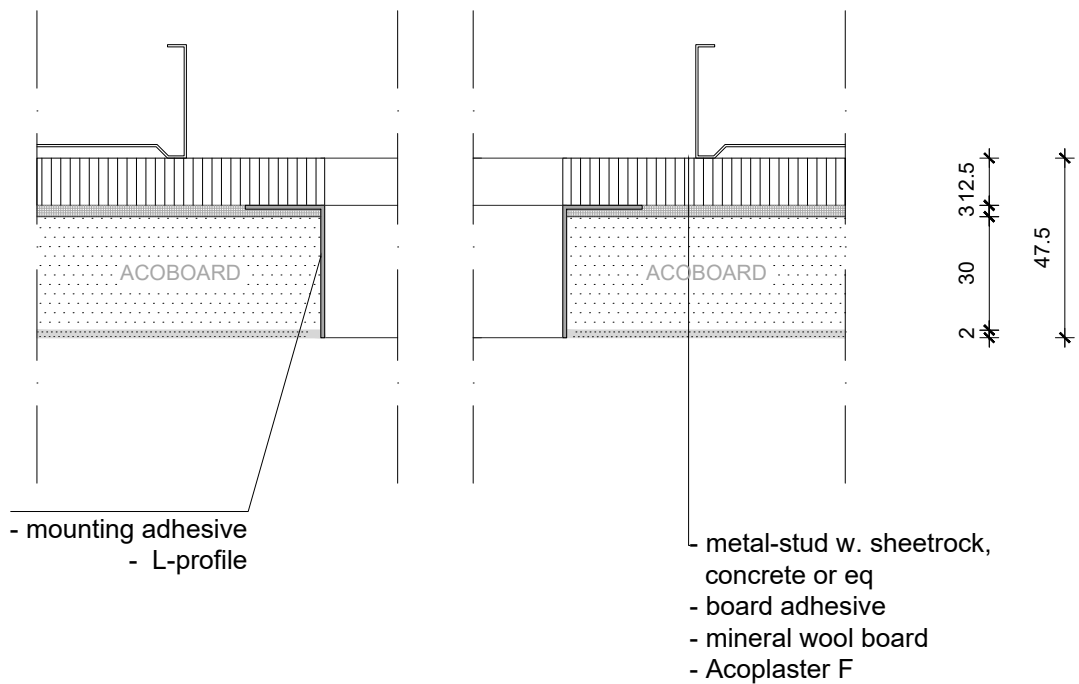

NOTE:

- Acosorb products always need to be applied accordingly to the instructions by Acosorb on clean, dry and non expanding surfaces like concrete, gypsum or eq
Dimensions of profiles and other products depends on the applied thickness of Acosorb product.

Product:	ACOPLASTER F RECTANGULAR OPENING	Date:	V1.0 2019	info@acosorb.com
Scale:	1:2	Drawn by:	ACOSORB	WWW.ACOSORB.COM
Papersize:	A4	 seamless acoustical spray- and plasterwork		

* These details are basic principle drawings. This drawing does not function as or will replace any execution drawings.
The client or contractor is responsible for the correct application of the product. All dimensions need to be checked by client or contractor.

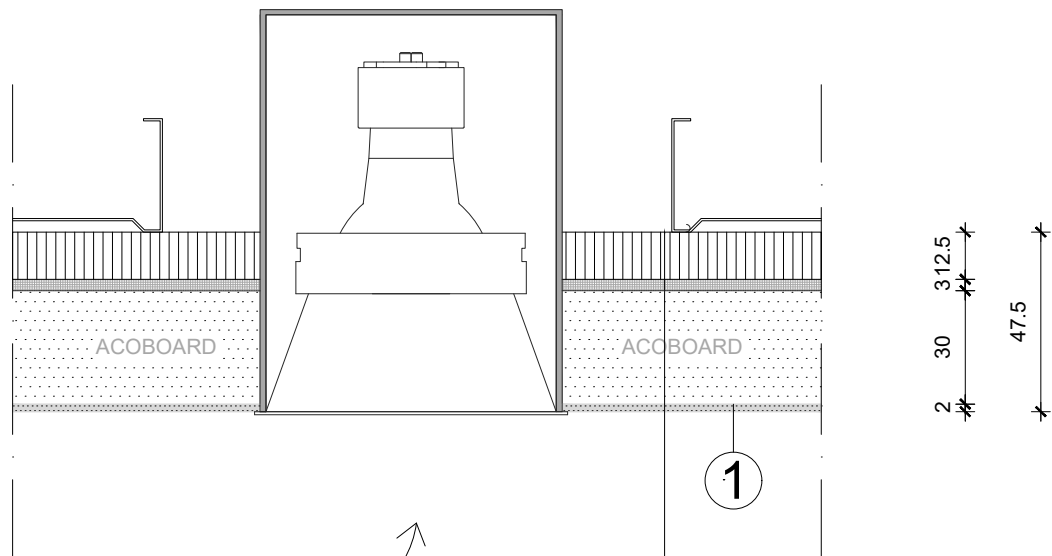

- 1 - metal-stud w. sheetrock, concrete or eq
 - board adhesive
 - mineral wool board
 - Acoplaster F

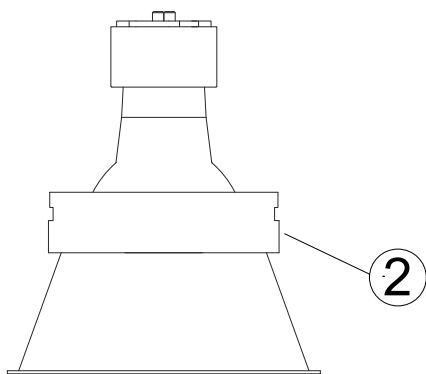

- 1 - spray ceiling
 2 - place accessory

NOTE:

- Acosorb products always need to be applied accordingly to the instructions by Acosorb on clean, dry and non expanding surfaces like concrete, gypsum or eq
 Dimensions of profiles and other products depends on the applied thickness of Acosorb product.

Product:	ACOPLASTER F CEILING Item RECESSED	Date:	V1.0 2019	info@acosorb.com
Scale:	1:2	Drawn by:	ACOSORB	WWW.ACOSORB.COM
Papersize:	A4	 seamless acoustical spray- and plasterwork		

* These details are basic principle drawings. This drawing does not function as or will replace any execution drawings. The client or contractor is responsible for the correct application of the product. All dimensions need to be checked by client or contractor.

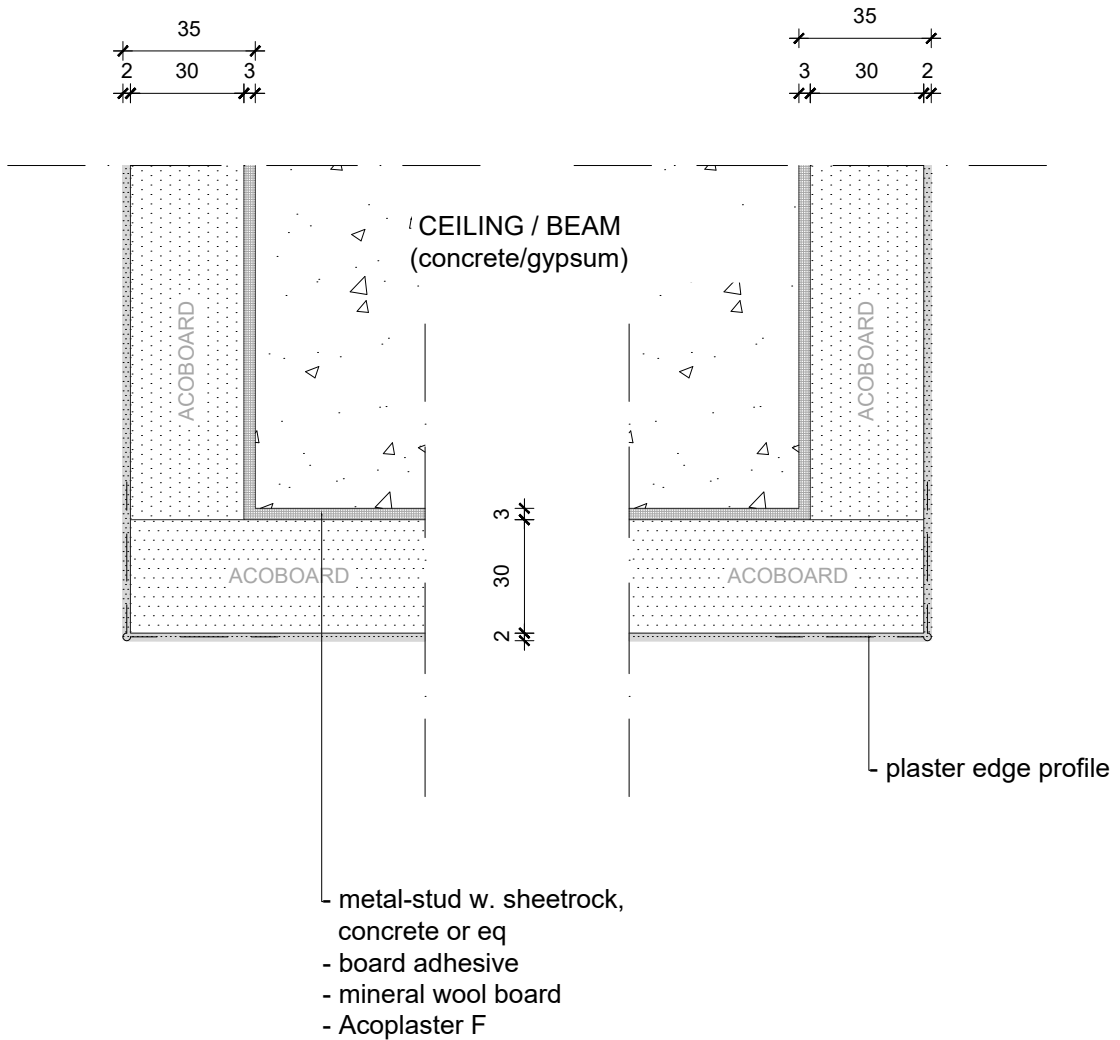

NOTE:

- Acosorb products always need to be applied accordingly to the instructions by Acosorb on clean, dry and non expanding surfaces like concrete, gypsum or eq
Dimensions of profiles and other products depends on the applied thickness of Acosorb product.

Product:	ACOPLASTER F BULKHEAD EDGE	Date:	V1.0 2019	info@acosorb.com
Scale:	1:2	Drawn by:	ACOSORB	WWW.ACOSORB.COM
Papersize:	A4			 seamless acoustical spray- and plasterwork

* These details are basic principle drawings. This drawing does not function as or will replace any execution drawings.
The client or contractor is responsible for the correct application of the product. All dimensions need to be checked by client or contractor.

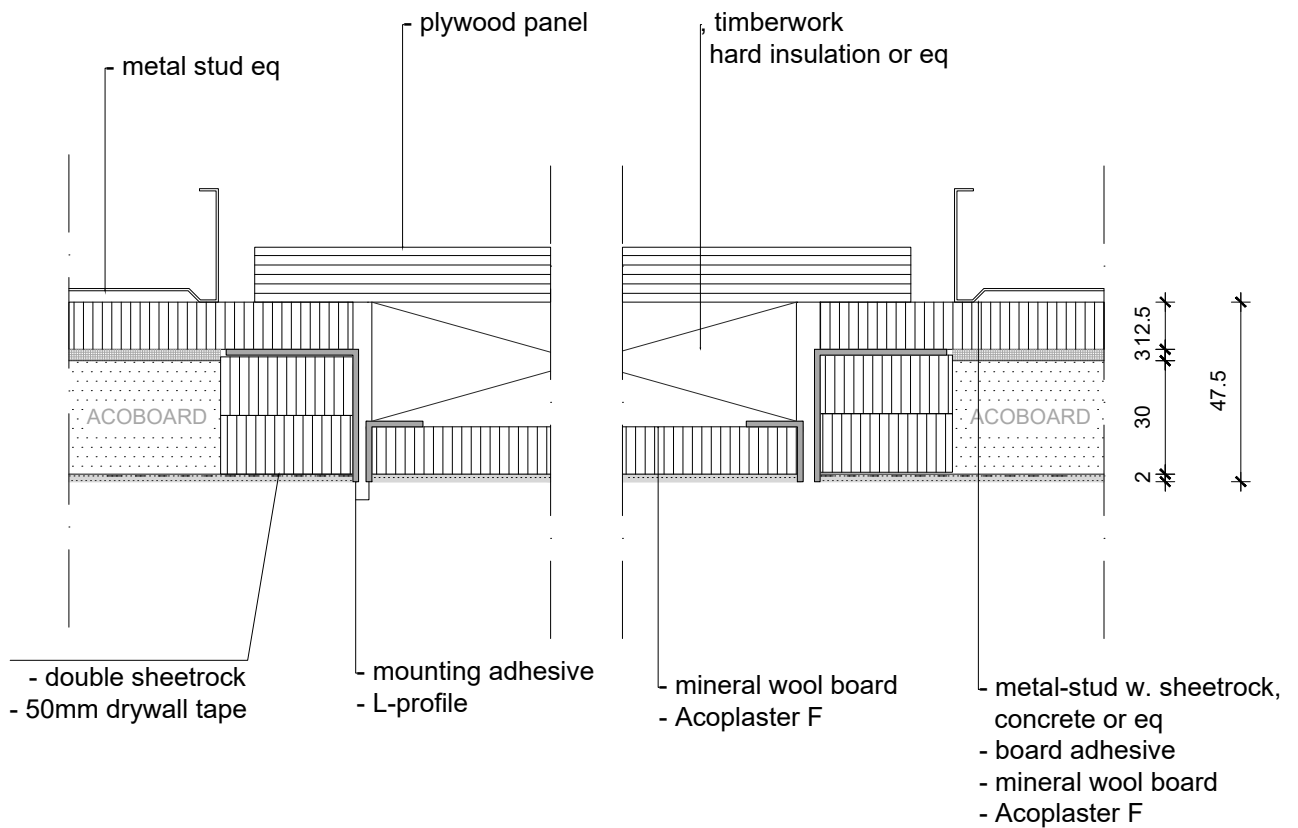

NOTE:

- Acosorb products always need to be applied accordingly to the instructions by Acosorb on clean, dry and non expanding surfaces like concrete, gypsum or eq
Dimensions of profiles and other products depends on the applied thickness of Acosorb product.

Product:	ACOPLASTER F INSPECTION HATCH	Date:	V1.0 2019	info@acosorb.com
Scale:	1:2	Drawn by:	ACOSORB	WWW.ACOSORB.COM
Papersize:	A4	 seamless acoustical spray- and plasterwork		

* These details are basic principle drawings. This drawing does not function as or will replace any execution drawings.
The client or contractor is responsible for the correct application of the product. All dimensions need to be checked by client or contractor.

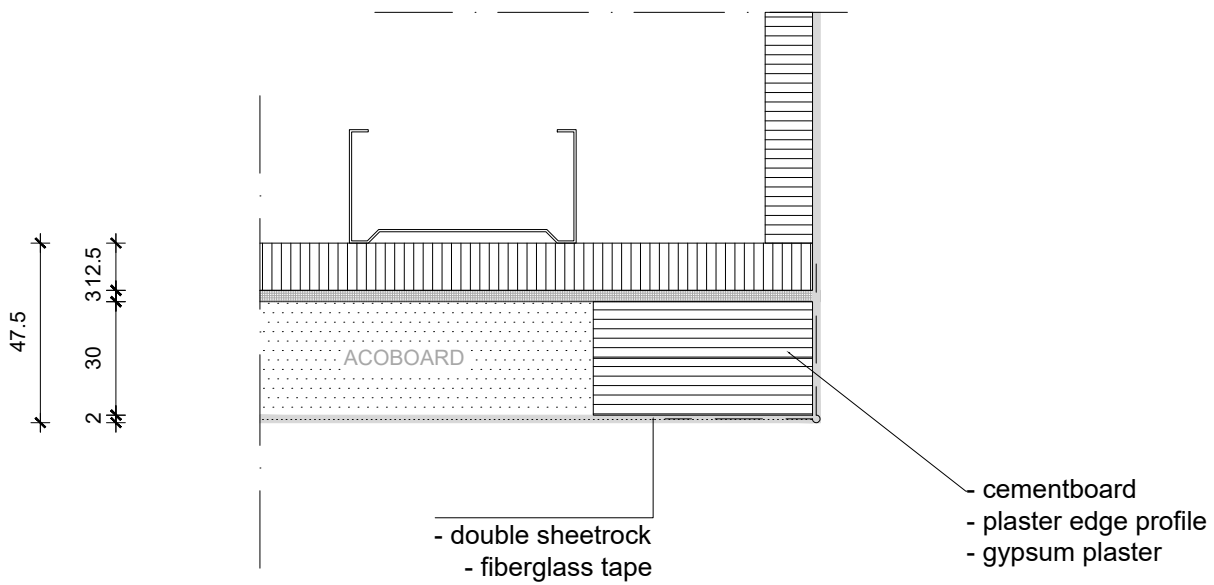

VERTICAL DETAIL

NOTE:

- Acosorb products always need to be applied accordingly to the instructions by Acosorb on clean, dry and non expanding surfaces like concrete, gypsum or eq
 Dimensions of profiles and other products depends on the applied thickness of Acosorb product.

Product:	ACOPLASTER F ATRIUM / EDGE	Date:	V1.0 2019	info@acosorb.com
Scale:	1:2	Drawn by:	ACOSORB	WWW.ACOSORB.COM
Papersize:	A4			 seamless acoustical spray- and plasterwork

* These details are basic principle drawings. This drawing does not function as or will replace any execution drawings.
 The client or contractor is responsible for the correct application of the product. All dimensions need to be checked by client or contractor.

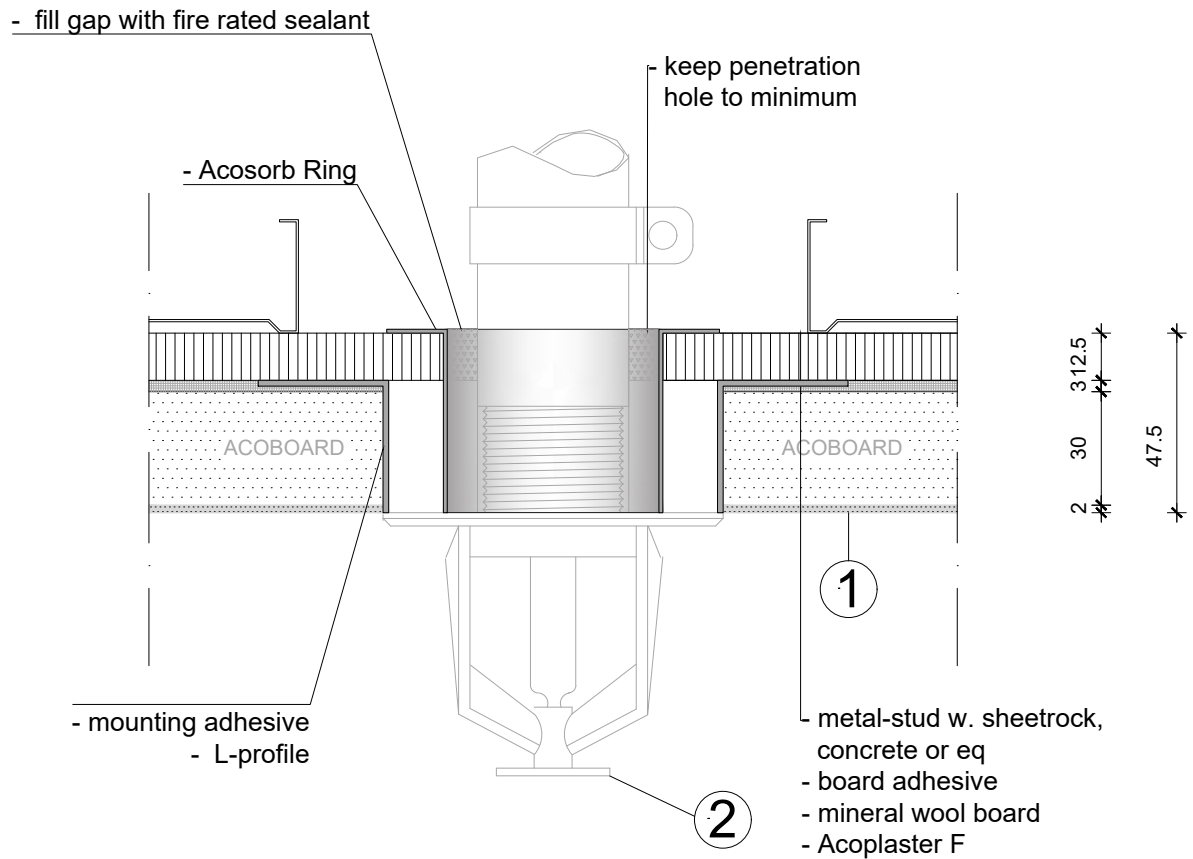

NOTE:

- Acosorb products always need to be applied accordingly to the instructions by Acosorb on clean, dry and non expanding surfaces like concrete, gypsum or eq
Dimensions of profiles and other products depends on the applied thickness of Acosorb product.

1 - spray ceiling
2 - place accessory

Product:	ACOPLASTER F SPRINKLER	Date:	V1.0 2019	info@acosorb.com	
Scale:	1:2	Drawn by:	ACOSORB	WWW.ACOSORB.COM	
Papersize:	A4				

* These details are basic principle drawings. This drawing does not function as or will replace any execution drawings.
The client or contractor is responsible for the correct application of the product. All dimensions need to be checked by client or contractor.

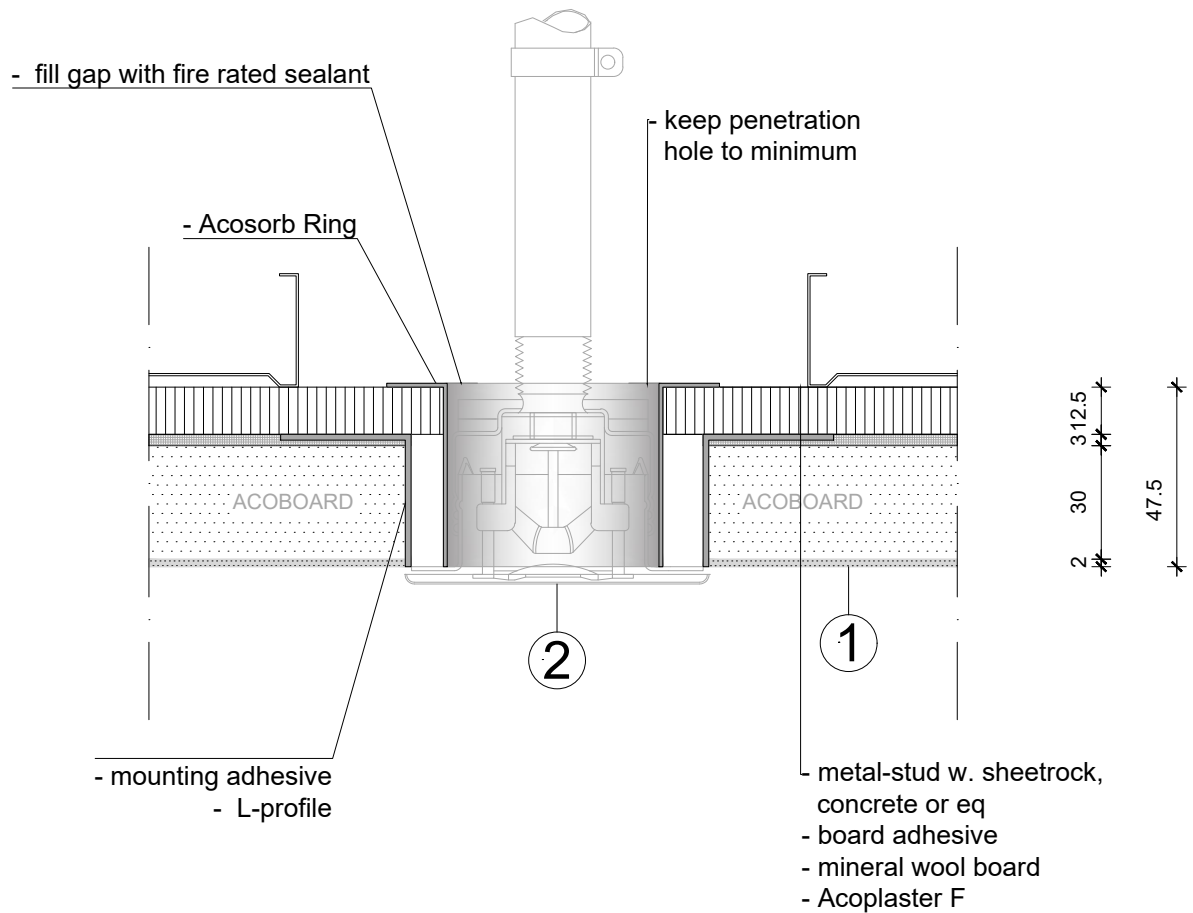

NOTE:

- Acosorb products always need to be applied accordingly to the instructions by Acosorb on clean, dry and non expanding surfaces like concrete, gypsum or eq
Dimensions of profiles and other products depends on the applied thickness of Acosorb product.

1 - spray ceiling
2 - place accessory

Product:	ACOPLASTER SPRINKLER RECESSER	Date:	V1.0 2019	info@acosorb.com	
Scale:	1:2	Drawn by:	ACOSORB	WWW.ACOSORB.COM	
Papersize:	A4				

* These details are basic principle drawings. This drawing does not function as or will replace any execution drawings. The client or contractor is responsible for the correct application of the product. All dimensions need to be checked by client or contractor.

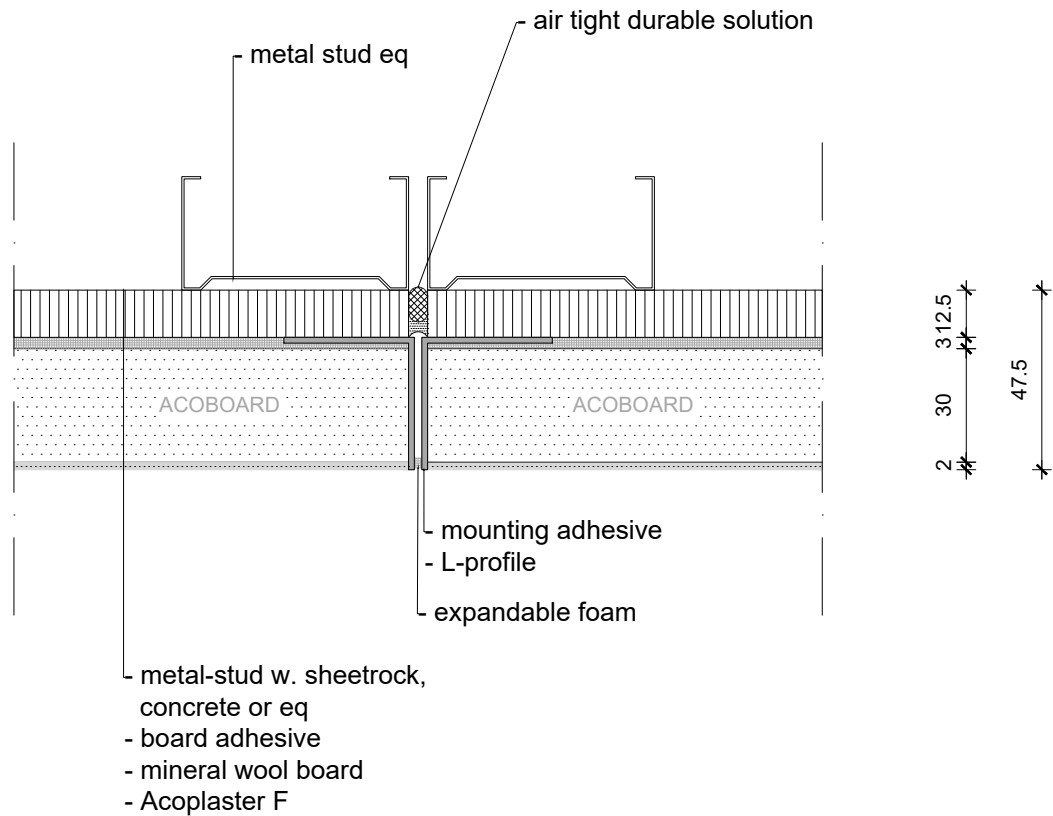

NOTE:

- Acosorb products always need to be applied accordingly to the instructions by Acosorb on clean, dry and non expanding surfaces like concrete, gypsum or eq
Dimensions of profiles and other products depends on the applied thickness of Acosorb product.

Product:	ACOPLASTER F EXPANSION JOINT	Date:	V1.0 2019	info@acosorb.com
Scale:	1:2	Drawn by:	ACOSORB	WWW.ACOSORB.COM
Papersize:	A4	 seamless acoustical spray- and plasterwork		

* These details are basic principle drawings. This drawing does not function as or will replace any execution drawings.
The client or contractor is responsible for the correct application of the product. All dimensions need to be checked by client or contractor.

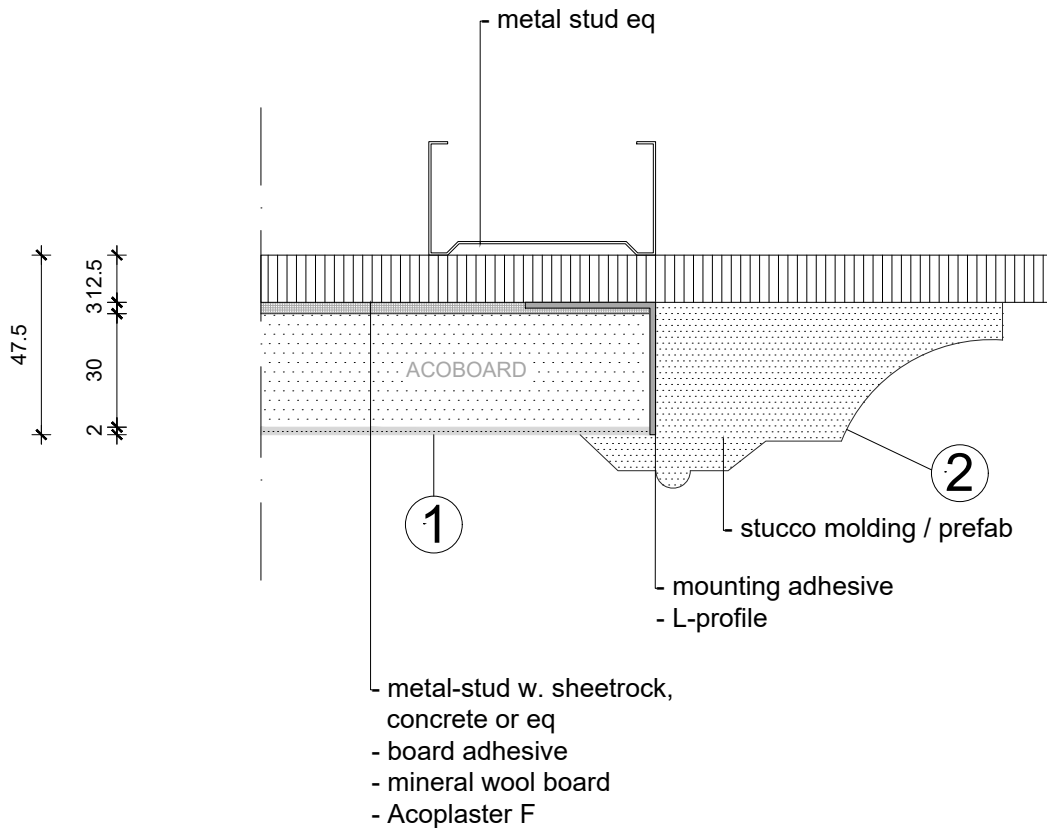

1 - spray ceiling
2 - mount stucco-profile

NOTE:

- Acosorb products always need to be applied accordingly to the instructions by Acosorb on clean, dry and non expanding surfaces like concrete, gypsum or eq
Dimensions of profiles and other products depends on the applied thickness of Acosorb product.

Product:	ACOPLASTER F STUCCO MOLDING / PREFAB	Date:	V1.0 2019	info@acosorb.com
Scale:	1:2	Drawn by:	ACOSORB	WWW.ACOSORB.COM
Papersize:	A4			 seamless acoustical spray- and plasterwork

* These details are basic principle drawings. This drawing does not function as or will replace any execution drawings.
The client or contractor is responsible for the correct application of the product. All dimensions need to be checked by client or contractor.

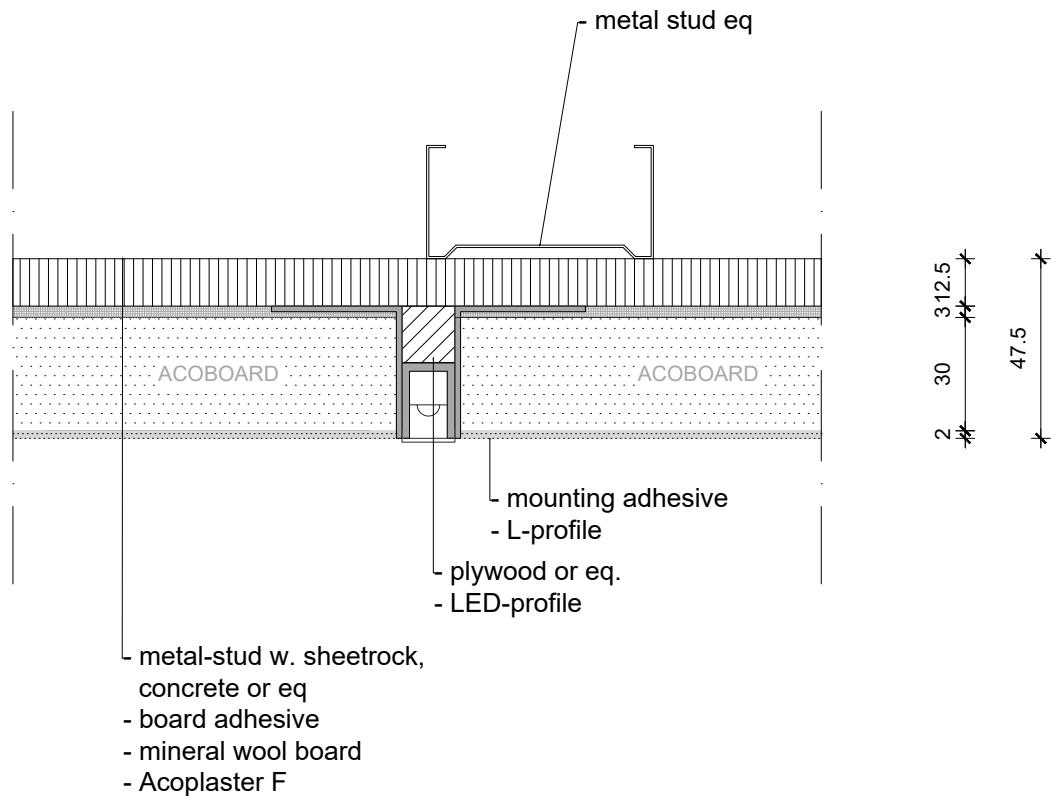
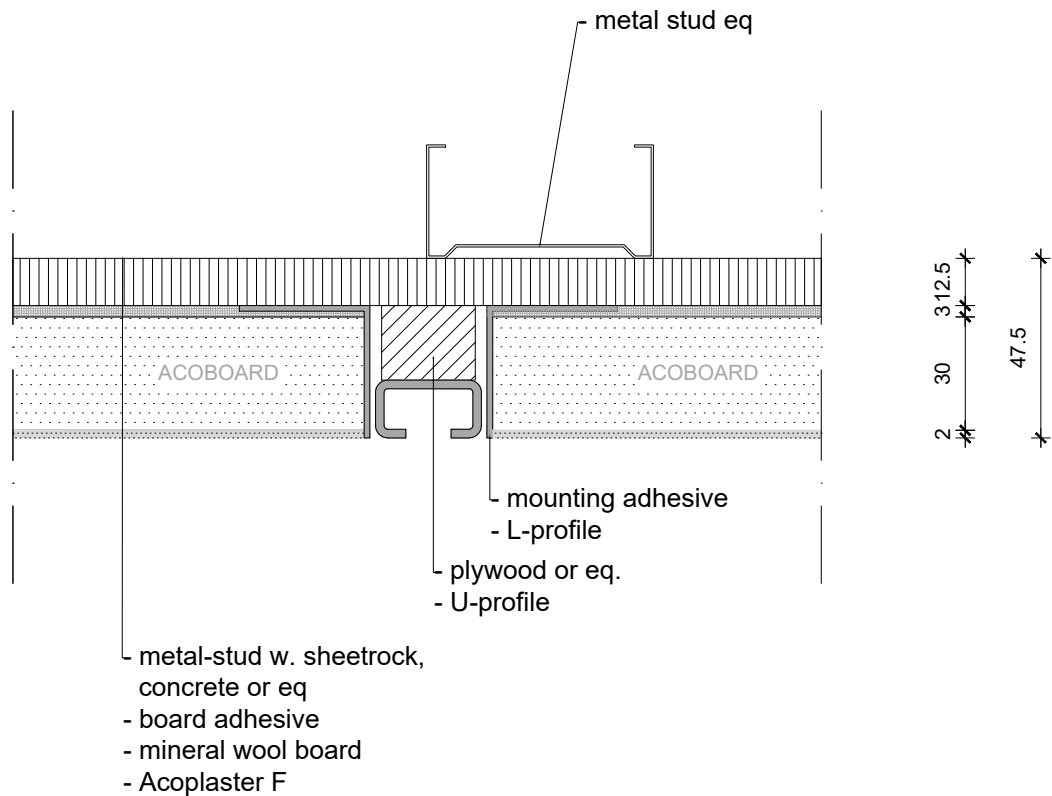

NOTE:

- Acosorb products always need to be applied accordingly to the instructions by Acosorb on clean, dry and non expanding surfaces like concrete, gypsum or eq
Dimensions of profiles and other products depends on the applied thickness of Acosorb product.

Product:	ACOPLASTER F U-PROFILE, LIGHT/LED LINE	Date:	V1.0 2019	info@acosorb.com
Scale:	1:2	Drawn by:	ACOSORB	WWW.ACOSORB.COM
Papersize:	A4			 seamless acoustical spray- and plasterwork

* These details are basic principle drawings. This drawing does not function as or will replace any execution drawings.
The client or contractor is responsible for the correct application of the product. All dimensions need to be checked by client or contractor.

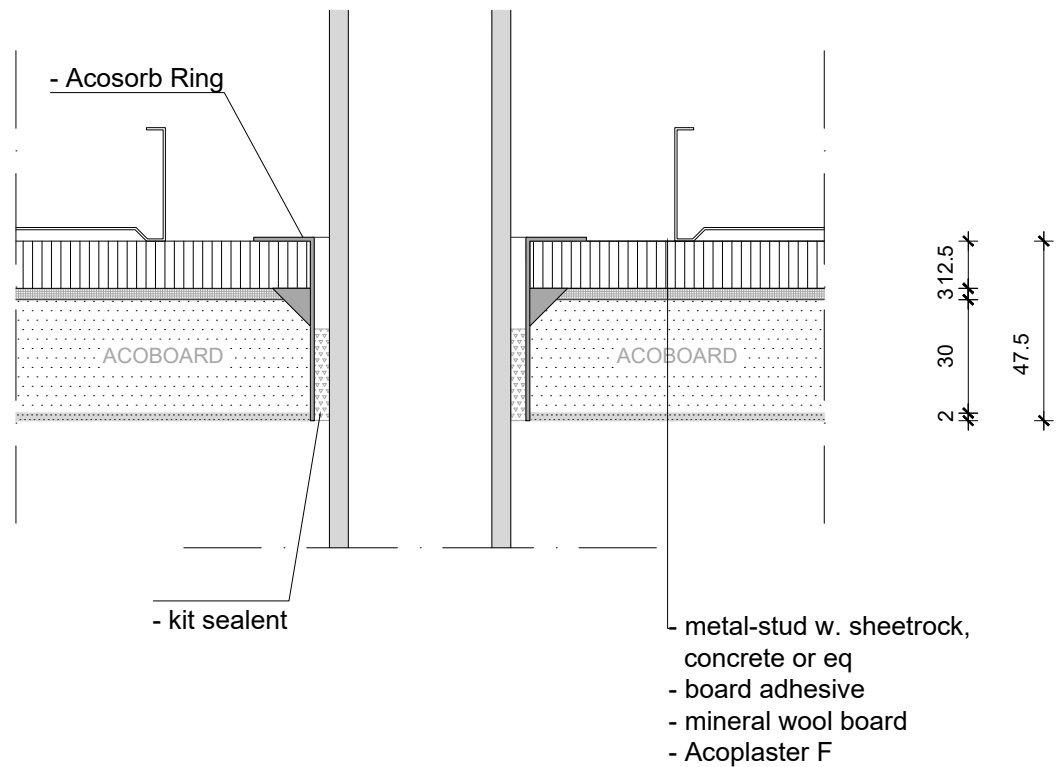

NOTE:

- Acosorb products always need to be applied accordingly to the instructions by Acosorb on clean, dry and non expanding surfaces like concrete, gypsum or eq
 Dimensions of profiles and other products depends on the applied thickness of Acosorb product.

Product:	ACOPLASTER F TUBE TRANSIT	Date:	V1.0 2019	info@acosorb.com
Scale:	1:2	Drawn by:	ACOSORB	WWW.ACOSORB.COM
Papersize:	A4	 seamless acoustical spray- and plasterwork		

* These details are basic principle drawings. This drawing does not function as or will replace any execution drawings.
 The client or contractor is responsible for the correct application of the product. All dimensions need to be checked by client or contractor.

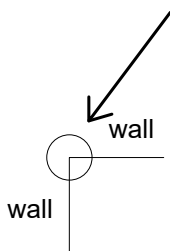
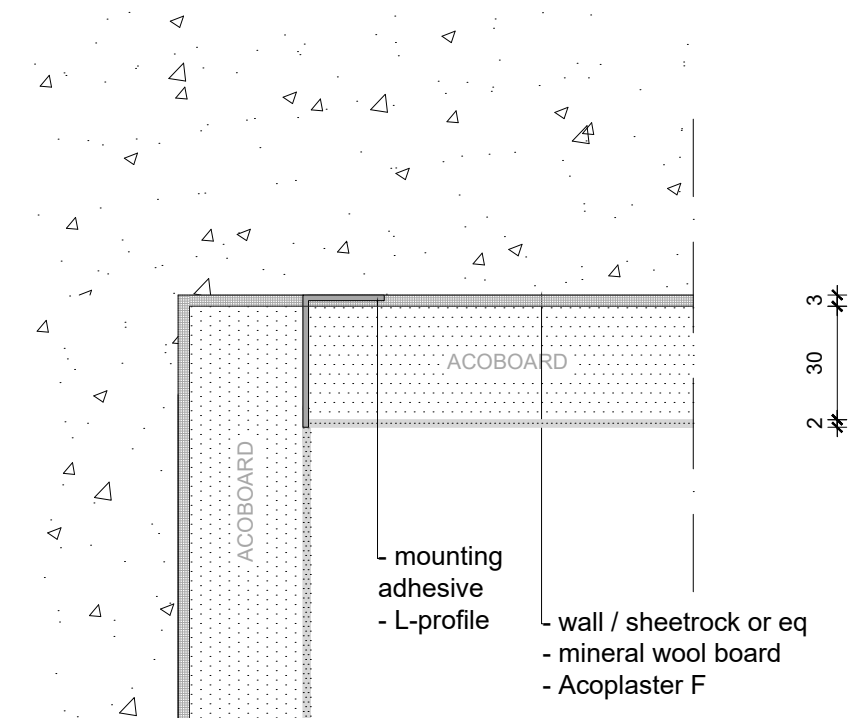

HORIZONTAL DETAIL!

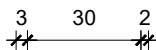

NOTE:

- Acosorb products always need to be applied accordingly to the instructions by Acosorb on clean, dry and non expanding surfaces like concrete, gypsum or eq
 Dimensions of profiles and other products depends on the applied thickness of Acosorb product.

Product:	ACOPLASTER F HORIZONTAL DETAIL	Date:	V1.0 2019	info@acosorb.com
Scale:	1:2	Drawn by:	ACOSORB	WWW.ACOSORB.COM
Papersize:	A4			 seamless acoustical spray- and plasterwork

* These details are basic principle drawings. This drawing does not function as or will replace any execution drawings.
 The client or contractor is responsible for the correct application of the product. All dimensions need to be checked by client or contractor.